

The Most Dependable Commercial Salt Chlorinators in The Industry.



ChlorKing® commercial saline chlorinators are leading the way to better, safer water. Their unique, forward-thinking design converts your pool into the mineral spa water you have always dreamed of. ChlorKing salt systems eliminate the costs, risks and smell associated with shipping and storing traditional chlorine. And they pay for themselves through lower cost of operation and a longer lasting system. ChlorKing's patented single cell technology ensures the need for only one system for your commercial pool or spa.

The CHLOR 20SM

The ChlorKing® CHLOR 20SM salt chlorinator is mounted onto any wall surface in the pump room and is plumbed into the existing pool circulation system. A mild saline solution of between 3,500 – 5,000ppm salt is introduced to the pool and flows through the cell to create hypochlorous acid. The ChlorKing® CHLOR 20SM is a single cell and is plumbed in a bypass for easy installation.

Main Features

- Patented single cell technology
- 4mm plate spacing designed for commercial pools
- Self cleaning (reverse polarity) or forward polarity
- 15,000 hour cell
- Clear reaction chamber for easy viewing
- Bypass installation with 1" plumbing
- Only 20gpm flow required
- Automatic salinity control
- Industrial switch-mode water cooled power supply
- Designed, manufactured and supported in the U.S.A

Specifications - CHLOR 20SM

- Certifications achieved
 - › NSF-50
 - › UL-1081
 - › CSA-C22.2
- Electrode stacks
 - › 1-22 lb, 15,000 hr in clear housing
- Electrical specifications
 - › Max primary amps – (15 @ 208v)
 - › Voltage / Hz – (208-240v 50/60Hz single phase)
 - › GFCI breaker required – (30 amp)
- Power supply
 - › Water cooled
- Operating temperature
 - › 35°F (2°C) to 115°F (46°C) air temperature
 - › 59°F (15°C) to 104°F (40°C) water temperature
- Plumbing / flow gpm
 - › 1 1/2" inlet and outlet
 - › 20 gpm (flow required)
 - › 50 psi (max pressure)
- Dimensions
 - › 20"W x 20"H (Power supply)
 - › 13"W x 28"H (Cell housing)
- Salt concentration & display
 - › 3,500 - 5,000ppm required
 - › Digital toroidal salt display
- Equivalent chlorine production
 - › 22 lbs / 24 hours
- Bonding and grounding
 - › Bonding lugs and grounding Ts included
 - › Bonding and grounding of this system is essential
 - › Bonding and grounding of all equipment in the pump room is required.



Order Information

- Product code: CHLOR 20SM - Reverse polarity
CHLOR 20CSM - Forward polarity

CHLOR 20SM Dimensions & Plumbing

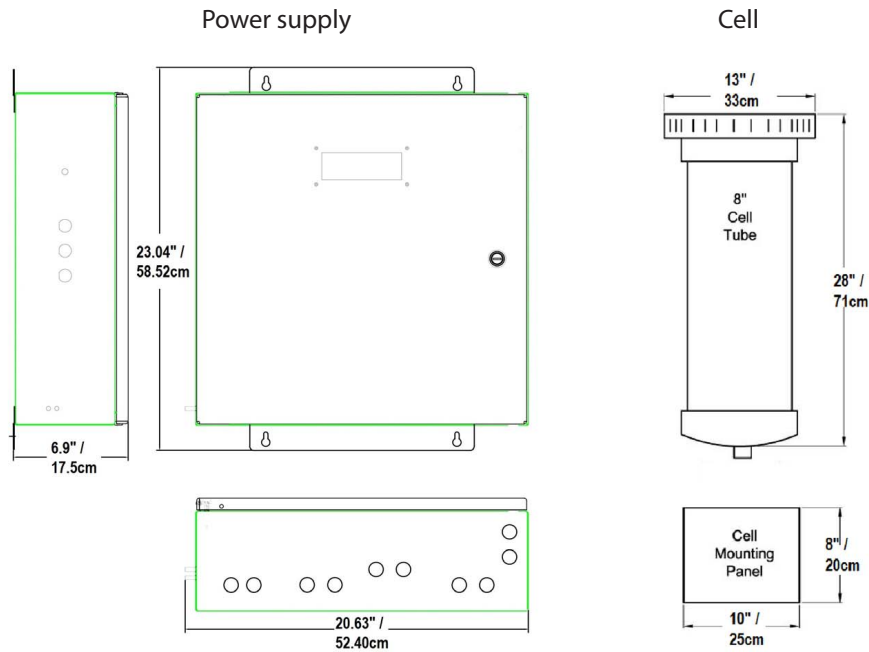

Installation

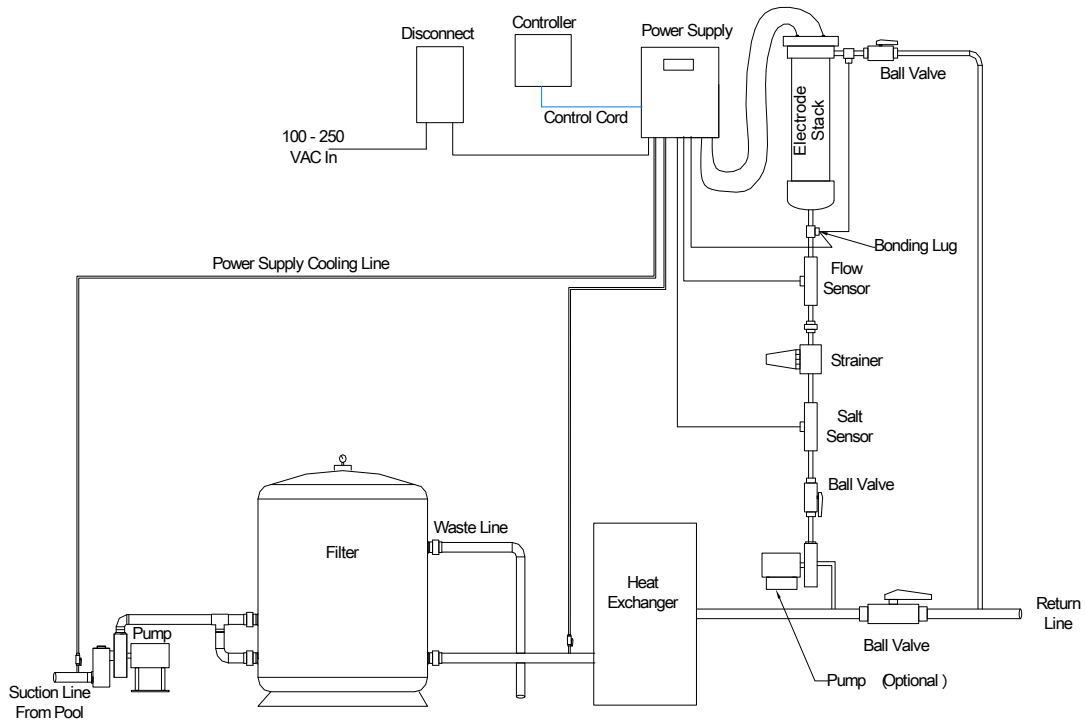

ChlorKing pioneered on-site chlorine generating technology in the 1970's. Realizing the potential for swimming pools and commercial applications, the company began generating "ultimate water" with simple, yet highly advanced technology. Today, ChlorKing® leads the way in commercial saline chlorination and is consistently seeking new frontiers in sanitizing solutions including ultraviolet light technology and their NEX-GEN® pH onsite chlorine generators. These environmentally friendly solutions are changing the way we treat H₂O.



Saferwaterthroughsmartertechnology.

Salt Chlorination Systems • Ultraviolet Light Systems • Mixed Oxidant Systems